

Medium and fine protection for two-core systems 12 V

Technical data sheet Medium and fine protection for two-core systems 12 V



Surge protection for use in measurement and control technology

- Medium and fine protection
- Standard design for single core systems
- Two-stage protection circuit
- With installation-friendly, screwless connection terminals
- In space-saving 17.5 mm grid
- With inductive decoupling in the longitudinal branch

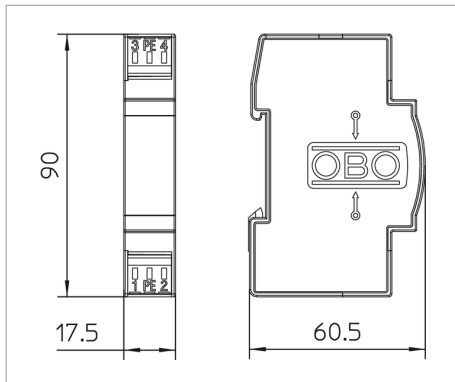

Application: Universal use on any 35 mm hat profile rail in every commercially available distributor housing.

Type	U max DC V	U max AC V	Pack Units	Weight kg/100 pc.	Art.-No.
FLD 5		4.2	1	5.200	5098600
FLD 12		9.5	1	5.200	5098603
FLD 24		19	1	5.200	5098611
FLD 48		37.5	1	5.200	5098630
FLD 60		66	1	5.200	5098638
FLD 110		86.2	1	5.200	5098646



G /pc.



Connection-/Circuit diagram

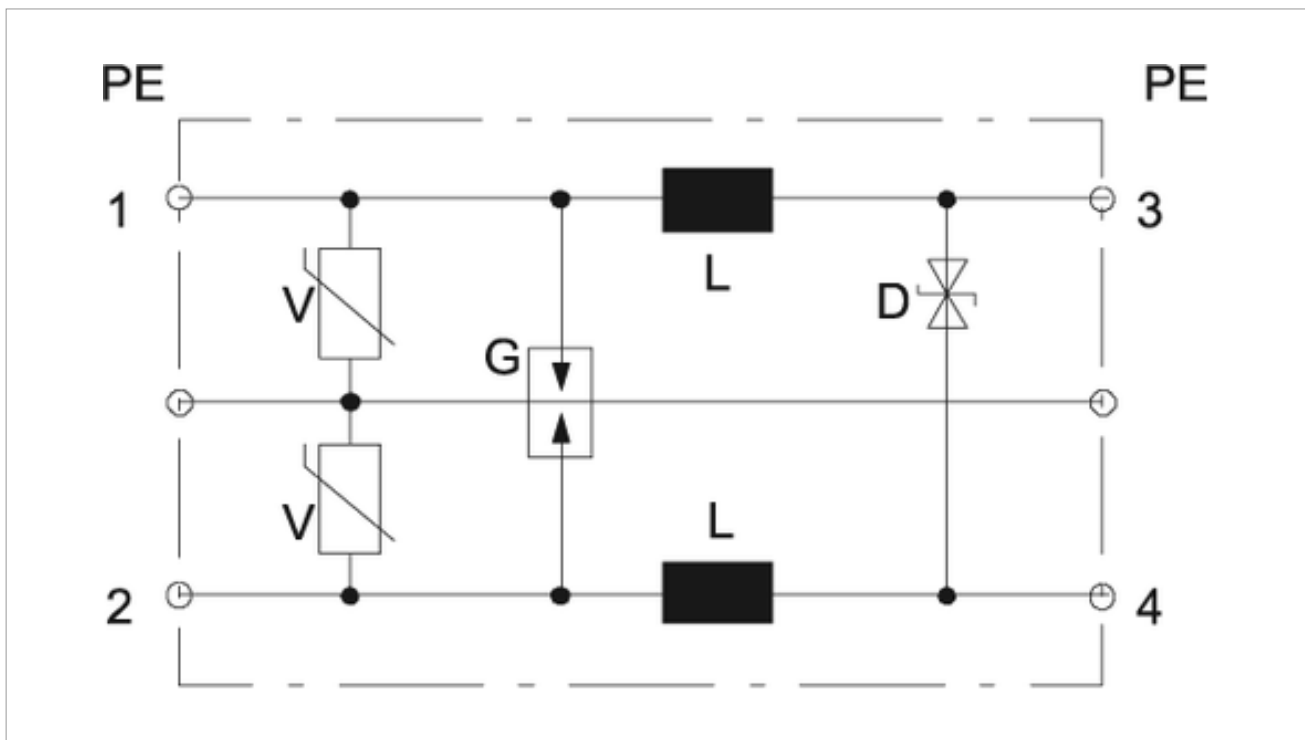

Article number			5098600	5098603	5098611	5098630	5098638	5098646
Nominal voltage	U_N	V	5	12	24	48	60	110
U max AC	$U_{C AC}$	V	4.2	9.5	19	37.5	66	86.2
LPZ			0?3	0?3	0?3	0?3	0?3	0?3
Lightning impulse current (10/350)	i_{imp}	kA	6	6	6	6	6	6
Nominal discharge surge current (8/20)	I_n	kA	10	10	10	10	10	10
Nominal load current	I_L	A	1	1	1	1	1	1
Protection level wire/wire	V		<18	<32	<65	<125	<150	<255
Protection level wire/earth	V		<500	<500	<500	<500	<500	<500
Response time	t_A	ns	< 1	< 1	< 1	< 1	< 1	< 1
Temperature range	?	°C	-40	-40	-40	-40	-40	-40
Division unit TE (17.5 mm)			1	1	1	1	1	1
Connection cross-section, rigid	mm ²		0.14	0.14	0.14	0.14	0.14	0.14
Connection cross-section, multi-wire	mm ²		0.14	0.14	0.14	0.14	0.14	0.14
Connection cross-section, flexible	mm ²		0.14	0.14	0.14	0.14	0.14	0.14

Legend



Transition from LPZ 0 to LPZ 3



Measuring, controlling and regulating systems



Communautés Européennes, EC declaration of conformity according to EC directives



Russia, GOST The State Committee for Standards



5-year warranty